



Systeme Modulaire de Construction



Modular Construction System



Jeu de MÉCCANO pour adultes

Le DMSYSTEM est un système modulaire intermédiaire de construction qui permet aux utilisateurs de fabriquer sur mesure des étagères, des établies, des chariots et tout autres ensembles issus de leur imagination.

Sans soudure, ni peinture, le DMSYSTEM est re-configurable et ses composantes sont entièrement réutilisables, ce qui en fait un des systèmes les plus polyvalents.

Le DMSYSTEM est composé de tuyaux d'acier recouverts d'une résine aux couleurs variée, de raccords en acier plaqués au zinc, de roues variées, et d'une gamme d'accessoires complémentaires.



MECCANO set for grown ups

DMSYSTEM is an intermediate modular construction system that allows users to fabricate custom shelving, work benches, carts and any other items issued from their imagination.

DMSYSTEM requires no welding or painting. Assemblies are easily modified, and each and every component is reusable, making of it a very friendly user system.

DMSYSTEM consists of resin coated steel tubing, steel zinc plated connectors, various casters, and a complete assortment of complementary components.



Une version industrielle haut de gamme de ce système, le système **FASTUBE™** est aussi disponible chez...



At Denmar-Tech you will also find an industrial high end version of this system, the **FASTUBE™** system.



■■■■ DÉFLEXION / DEFLECTION

CALCUL DE LA DÉFLEXION:
DEFLECTION FORMULA:

$$D = W \times L^3 \times 0.00000006$$

EX. D = DÉFLEXION/DEFLECTION
W = POIDS/WEIGHT (100 LBS)
L = LONGUEUR/LENGTH (24")

$$100 \times 24^3 \times 0.00000006 = 0.083"$$

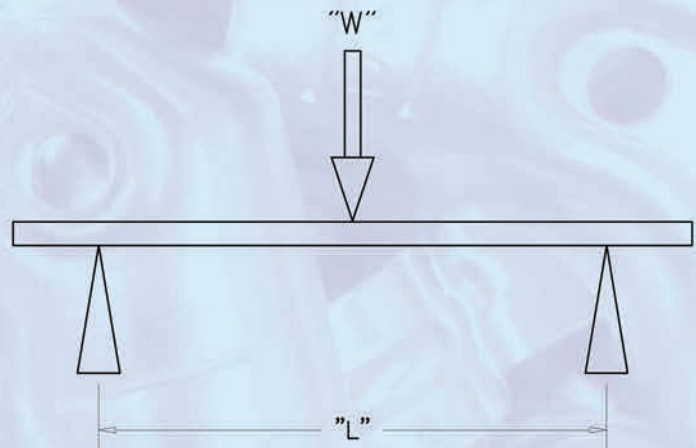

■■■■ CAPACITÉ / CAPACITY

"A"	LIMITE/LIMIT
18"	300 LBS
36"	150 LBS
48"	100 LBS
60"	80 LBS

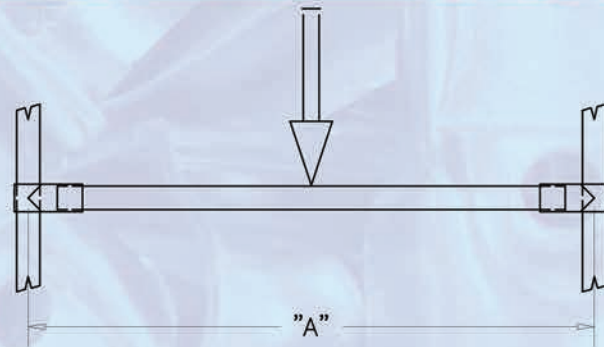

■■■■ CONSTRUCTION

DIMENSIONS DE CONSTRUCTION
CONSTRUCTION DIMENSIONS

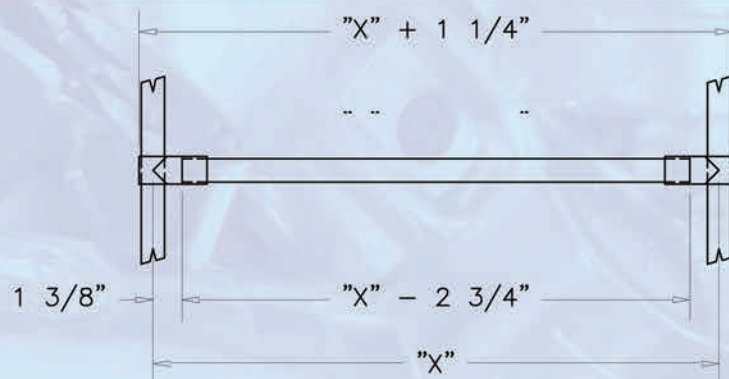

■■■■ OUTILS / TOOLS

OUTILS DE BASE REQUIS: CLÉ HEX 3/16, SCIE À MÉTAL, RUBAN À MESURER, MAILLET DE CAOUTCHOUC
BASIC TOOLS REQUIRED: 3/16 ALLEN KEY, METAL SAW, MEASURING TAPE, RUBBER Mallet



APPLICATIONS



**ROUES À TIGES
STEM CASTERS**



**ROUES À BOULONNER
BOLT-ON CASTERS**



DM1 + DM1



DM2 + DM3



DM2 (2) + DM4



DM2 (4)



DM4 + DM4



DM5 + DM5



DM5 (2) + DM6 (2)



DM7 + DM7



DM10A + DM10B



DM11 + DM11



DM13 + DM13



DM23 (4 PCS)



DM24 (3 PCS)

**CES DIFFÉRENTS
ENSEMBLES
REQUIÈRENT DES
BOULONS DMFS1 ET
DES ÉCROUS DMFS2**

**THOSE DIFFERENT
ASSEMBLES REQUIRE
DMFS1 BOLTS AND
DMFS2 SQUARE NUTS**



TUYAUX / TUBES



11 COULEURS
11 COLORS



DM3000BK



DM3000BL



DM3000BN



DM3000GN



DM3000GR



DM3000IV



DM3000LGN



DM3000OR



DM3000RD



DM3000WH



DM3000YL



CONVOYEUR / CONVEYOR



CONVOYEUR À GRAVITÉ
GRAVITY FLOW RACK

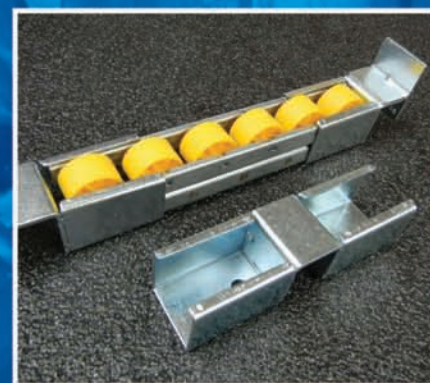

DM2046

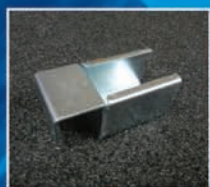

DM2044C



DM2044D

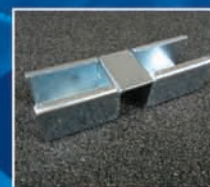

DM2044E



RACCORDS / CONNECTORS



DM1



DM2



DM3



DM4



DM5



DM6



DM7



DM10



DM11



DM13



DM23



DM24



ROUES / CASTERS



DM1000A



DM1002F



DM304 (3'')



DM305 (3'')



DM401 (4'')



DM402 (4'')



DM403 (4'')



DM404 (4'')



DM405 (4'')



DM601 (6'')



DM602 (6'')



DM603 (6'')

LES ROUES À BOULONNER REQUIÈRENT LES KITS DE BOULONS N° DMFS3
BOLT-ON CASTERS REQUIRES BOLT KITS N° DMFS3



ACCESSOIRES / ACCESSORIES



DM25



DM110



DM140



DM1008A



DM1200A



DM1200T



DM1202A



DM1010



DM1017S



DMFS1



DMFS2



DMFS3



DMTL3

D'autres "Accessoires Complémentaires" sont disponibles au www.denmartech.ca
Various other "Complementary Components" are available at www.denmartech.ca



RÉALISATIONS / PROJECTS



**CHARIOT À PNEUS
TIRE CART**



**SUPPORT À PNEUS
TIRE RACK**



**SUPPORT À BICYCLETTES
BICYCLE RACK**



**TABLE À PICNIC
PICNIC TABLE**



**ÉTABLIE
WORK BENCH**



**CHARIOT UTILITAIRE
UTILITY CART**



**SUPPORT POUR BÛCHES
FIRE WOOD RACK**



**BANC D'EXERCISE
BENCH PRESS**



**CONVOYEUR
CONVEYOR**

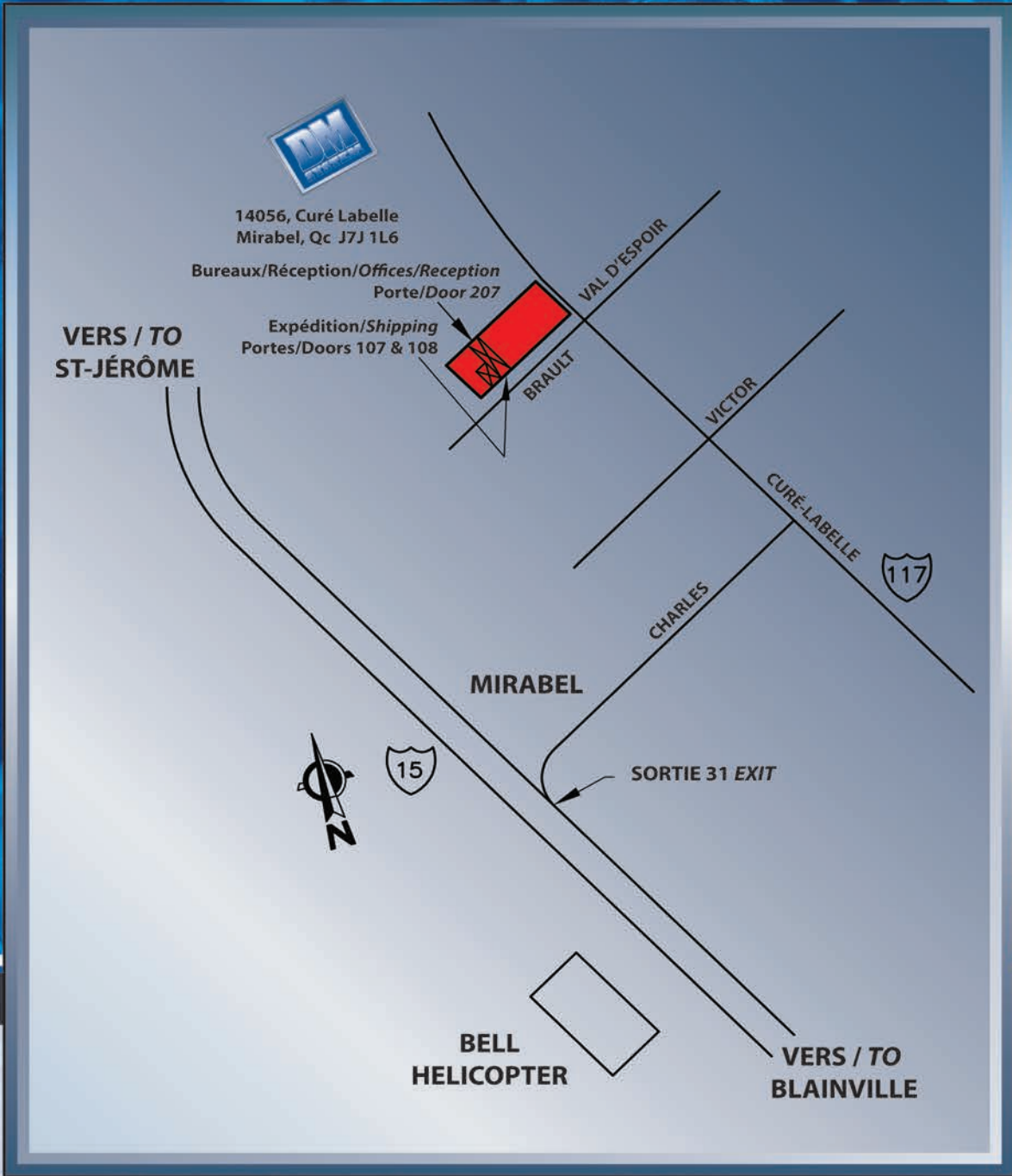

14056, boul. du Curé-Labelle, suite 207
Mirabel, Qc Canada J7J 1L6

Tél.: 450 979-3380
Fax: 450 979-4810
info@dmsystem.ca

